



First in Quality, First in Service.

AIR DISTRIBUTION PRODUCTS

VOLUME 8



OTTAWA

PRICE CONTROLS

GENERAL OFFICE APPLICATION

Rooftop Unit Controller

- The Price Rooftop Unit Controller (PRTU) polls data from the network zone controllers and intelligently controls the packaged roof top unit.
- The ASHRAE standard BACnet option allows for advanced control and monitoring of a building system.

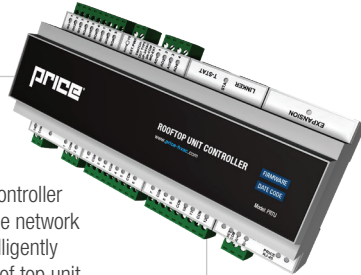

Remote System Access

- Access to the Price Web Server via the Internet.



Graphical User Interface

- Price Web Server pre-loaded with graphics for Price Controls.
- Access via any web browser with free ADOBE FLASH plug-in installed.
- No software or license (USB key) required.



Fan Powered Box with VAV Controller & Reheat

- Price's factory mounted and calibrated Price Intelligent Controller (PIC) for series and parallel fan power terminal units.
- Fan Powered Terminals allow for the use of local reheat even while the rooftop unit is turned off.

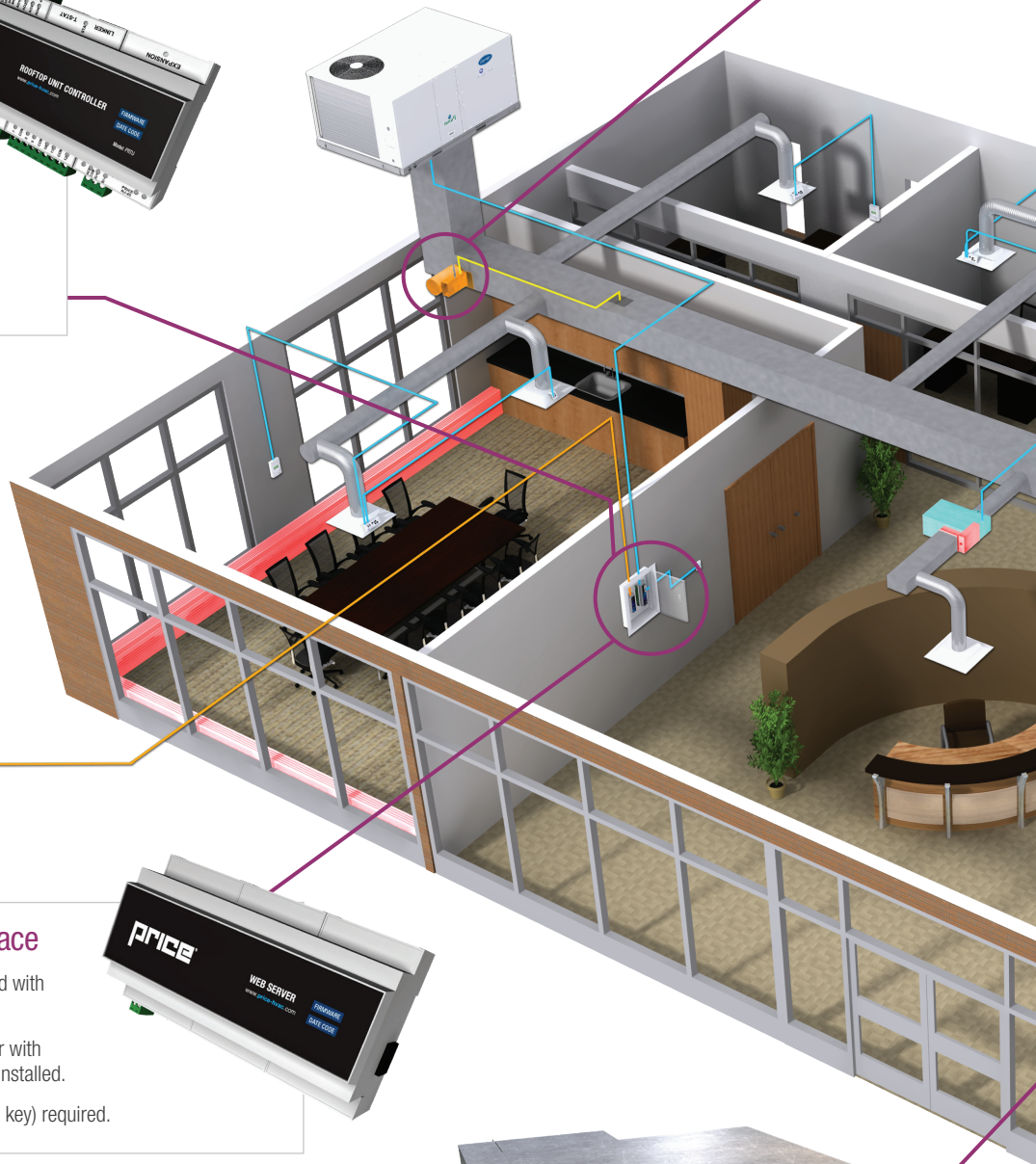
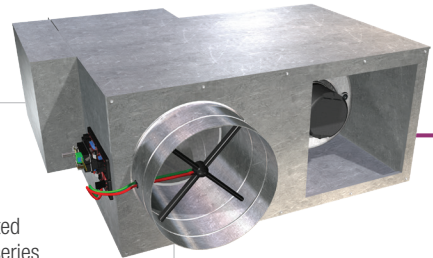

Duct Pressure Controller

- The Price PCV is designed as a pressure control valve to regulate duct pressure in a VAV or VVT system.
- The PCV uses a DDC controller to ensure that over or under pressurization of the duct will not occur.

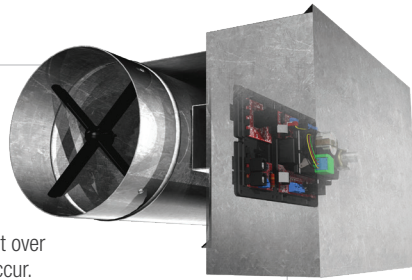

VAV Diffuser

- PRODIGY® Smart Diffuser.
- Stand-alone or native BACnet MS/TP.
- Compatible with all Price thermostats.

Linkersoft2 Software & LCD Setup Thermostat

- Easy to use step-by-step setup and calibration software, dedicated to Price Controls products.
- Connect the LINKER2 USB cable into your service laptop, or Price provided LCD Setup Thermostat, and the RJ12 connection into the room's thermostat or controller service port.

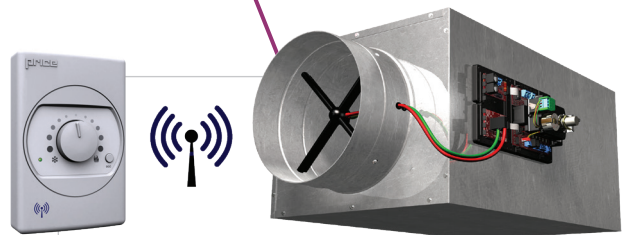
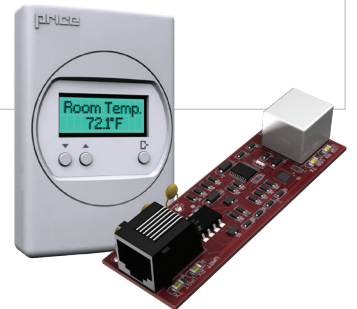

Single Duct Terminal with Wireless Thermostat

- Wireless thermostat allows for convenient, wire free placement in any room, on any surface.
- Compatible with our factory mounted calibrated Price Intelligent Controller (PIC).



Silencer Manufacturing: Woodbridge, Ontario

TORONTO-MADE SILENCERS

SMWIA-L30 YELLOW LABEL MANUFACTURING

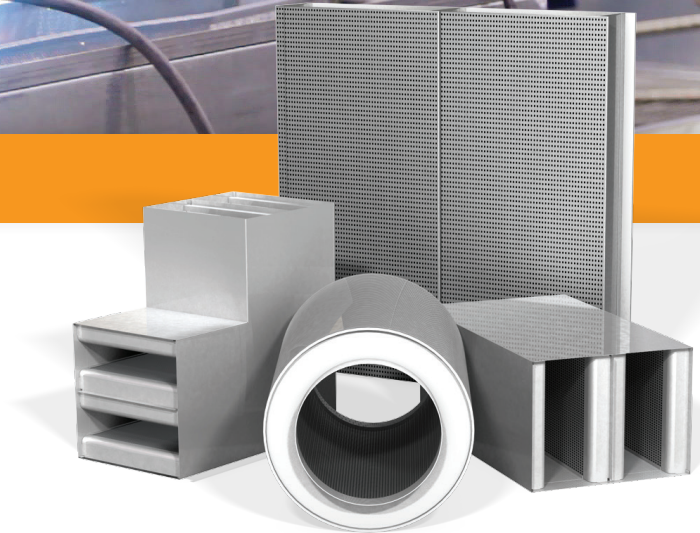

PRICE SILENCERS

Price offers a full line of high quality noise control solutions for any HVAC and most light industrial systems.

- + Rectangular, elbow and circular silencers
- + Absorptive, film-lined, and packless
- + Speech privacy and cross talk silencers
- + Custom silencers
- + Acoustic enclosures
- + Acoustical louvers

PRICE ACOUSTIC PANELS

Acoustic Panels are a highly effective method of controlling excessive equipment noise, and with tongue and groove construction, assembly is easy and installation time is minimized.

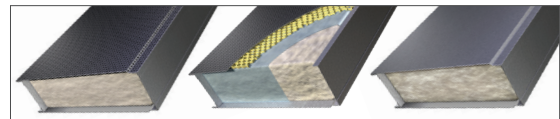

Standard Perforated/
Solid Metal Panel

Perforated/Solid Metal
Panel with Film Liner

Solid/Solid
Metal Panel

GRILLES, REGISTERS & DIFFUSERS

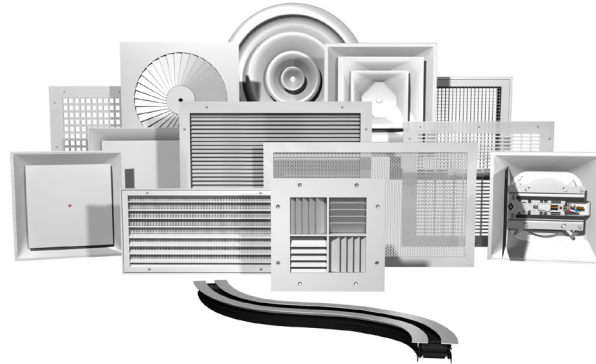

price | GRILLES

Price Industries Limited
www.priceindustries.com

- Grilles and Registers
 - Standard Grilles and Registers
 - Linear Bar Grilles
 - Airfoil Series Grilles and Registers
 - Industrial / Special Application
- Filter Grilles
- Condo Grilles
- Nozzles
- Security Products
- Heavy Duty Gym Grilles



price | DIFFUSERS

Price Industries Limited
www.priceindustries.com

- Linear Diffusers
 - Custom Flow Linear Diffusers
 - Linear Slot Diffusers
- Ceiling Component Diffusers
 - T-Bar Diffusers
 - Light Troffer Diffusers
 - Low Temperature Diffusers
- Ceiling Diffusers
 - Square Ceiling Diffusers
 - Perforated Ceiling Diffusers
 - Square and Rectangular Directional Diffusers
 - Round Cone Diffusers
 - VAV Diffusers



price | DISPLACEMENT

Price Industries Limited
www.priceindustries.com

- Displacement Ventilation
 - Wall Mounted Displacement Diffusers
 - In-Wall Displacement Diffusers
 - Free Standing Displacement Diffusers
- Floor Mounted Displacement Diffusers
- Ceiling Mounted Displacement Diffusers
- Linear Enclosure Displacement Diffusers
- Industrial Displacement Diffusers

price | UNDERFLOOR
MODUFLEX

Price Industries Limited
www.priceindustries.com

- Underfloor Air Distribution
 - Round Floor Diffusers
 - Linear Floor Grilles
 - Linear Floor Heaters
 - Power and Control Modules
- Underfloor Terminal Units
- Underfloor Deflection Grilles
- Vertical Fan Column
- Linear Floor Plenums

GRILLES, REGISTERS & DIFFUSERS CONT'D

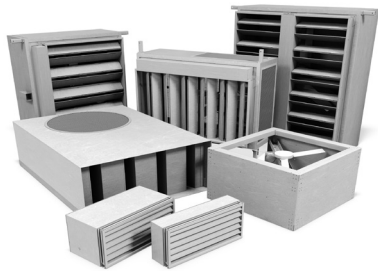

Price Industries Limited
www.priceindustries.com

- Natural Ventilation
 - Natural Ventilation Roof Stack
 - Roof Mounted Natural Ventilation
- Natural Ventilation Terminal
- Wall Mounted Air Transfer Unit



Acutherm
www.acutherm.com

- Square VAV Diffusers
- Round VAV Diffusers
- Linear VAV Diffusers
- Pressure Control Products
- Temperature Control Products



Air Concepts Inc.
www.airconceptsinc.com

- Directional Air Distribution Products
- Punkah Diffusers
- Nozzle Diffusers
- Industrial Diffusers



Air Louvers Inc.
www.activarcpg.com/air-louvers

- Fire Rated Door Grilles

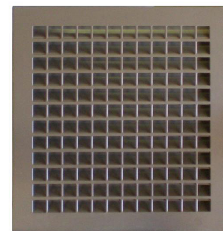

Krantz
www.krantz.de/en

- German Engineered and Manufactured Air Distribution
- Specialist in Premium Radial and Twist Diffusers



DuctSox
www.ductsox.com

- Fabric Duct Ventilation
- Fabric Faced Diffusers
- Final Filters
- Underfloor Fabric Duct



DAMPERS

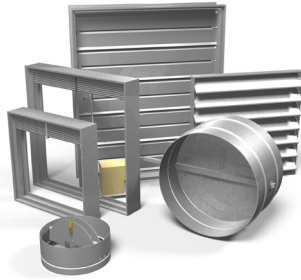

price | DAMPERS

Price Industries Limited
www.priceindustries.com

- Fire Dampers
- Smoke Dampers
- Fire / Smoke Dampers
- Ceiling Radiation Dampers
- Backdraft Dampers
- Control and Balancing Dampers
- Actuators
- Access Doors



TAMCO

TAMCO Innovative Damper Products
www.tamco.ca

- Premium Quality:
 - Thermally Insulated / Thermally Broken
 - Frame Control Dampers
- Aluminum Air-Foil Control Dampers
- High Quality Aluminum Backdraft Dampers

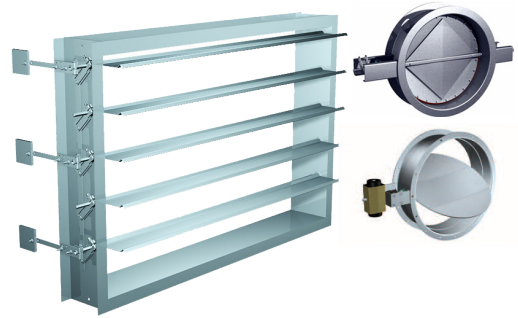

GREENHECK
 Building Value in Air.

Greenheck
www.greenheck.com

- Heavy Duty Industrial Dampers
- Severe Environment Dampers
- Bubble Tight Dampers



AAF | Flanders

AAF Flanders
www.aafintl.com

- Bubble Tight Dampers



Young Regulator
www.youngregulator.com

- Bowden Remote Control Dampers and Controllers
- Damper Regulators
- Motorized Dampers
- Manual Dampers
- Automatic Changeover Dampers

LOUVERS

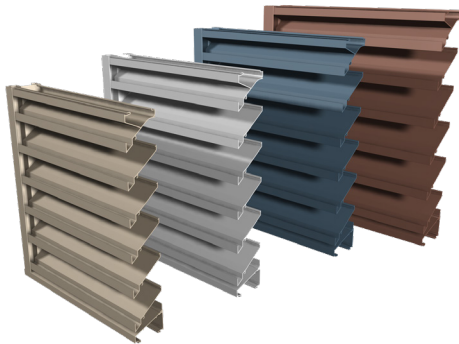

Price Industries Limited
www.priceindustries.com

- Formed Metal Louvers
- Extruded Louvers
- Standard Blade and Chevron Blade Acoustical Louvers
- Extruded Penthouse Louvers
- Formed Metal Penthouse Louvers
- Thinline Wall Application Louvers
- Rain Storm Louvers
- Wind-Driven Rain Louvers
- Sand Louvers
- Vision Screens
- Sightproof Louvers
- Louvered Shapes
- Louvered Doors
- Sunshades
- Equipment Screens
- Architectural Louvers
- Special Louvers as per Request



Greenheck
www.greenheck.com

- Sightproof Extruded Louvers
- Wind-Driven Rain Resistant Extruded Louvers
- Extruded Louvers with Integral Motorized Dampers
- Sand Louvers
- Penthouses and Penthouse Elevator Vents
- Brick Vents
- Equipment Screens



TERMINAL UNITS



TAMCO Innovative Damper Products
www.tamco.ca

- Premium Quality Aluminum Louvers



Price Industries Limited
www.priceindustries.com

- Single Duct Terminal Units
- Bypass Controller Type Terminal Unit
- Control Valves
- Dual Duct Terminal Units
- Fan Powered Terminal Units
- Induction Terminal Units
- Retrofit Terminal Units
- Special Application Terminal Units

NOISE & VIBRATION ISOLATION

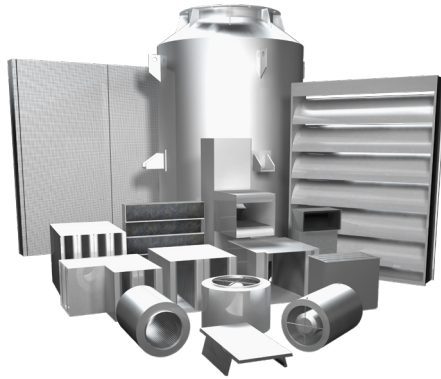

Price Industries Limited
www.priceindustries.com



VMC GROUP
 THE POWER OF TOGETHER

The VMC Group
www.thvmcgroup.com

- Commercial and Custom Silencers
- Rectangular, Elbow and Circular Silencers
- Absorptive, Film-Lined and Packless Silencers
- Air Transfer and Cross-Talk Silencers

- Acoustic Panels, Enclosures and Barriers
- Acoustical Louvers
- SMWIA-L30 Yellow Label Manufacturing

- Seismic Sway Bracing and Rod Stiffening Products
- Floor Mounted Seismically Restrained Isolators
- Spring Hangers

- Seismic / Vibration Isolating Roof Curbs
- Inertia Bases and Rails
- Flexible Connectors
- Piping Specialties
- Pad-Type Isolators

AIR FILTRATION – STANDARD & CRITICAL EXHAUST

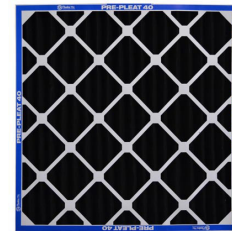
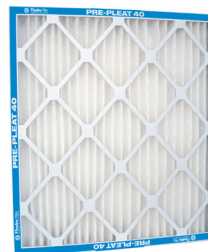
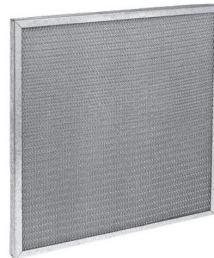

AAF Flanders
www.aafintl.com

- Paint Booth Products
- Air Filter Media and Auto Rolls
- Pleated Filters
- Medium and High Efficiency Rigid Type Air Filters

- Medium and High Efficiency Extended Surface Type Bag Filters
- Metal Washable Air and Grease Filters
- Odor Control Filters
- Carbon Absorbers

- 95% DOP and HEPA / ULPA Filters
- HEPA Housings and Holding Frames
- ASHRAE Side Access Housings and Holding Frames

- Cleanroom Ceiling Filters and Hoods
- Gaseous / Vapor Phase Sideload and Front Load Housings
- CSC Containment Air Filtration Systems (Bag-In / Bag-Out)

AIR PURIFICATION

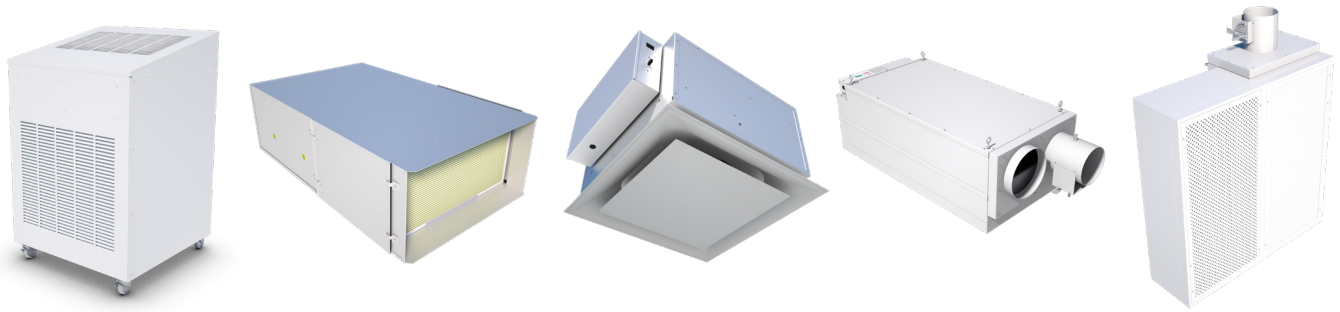

Price Industries Limited
www.priceindustries.com

RAP: Room Air Purifier

- Rapid purification for high density areas
- UL 2998 and UL 867 certified
- Simple plug and play design
- Optional bipolar ionization and UV light treatment

OAP: Overhead Air Purifier

- Premium installation flexibility
- Quiet air purification solution
- Ceiling mounted design to save valuable floor space
- Optional bipolar ionization and UV light treatment

CAP: Ceiling Air Purifier

- Ceiling concealed with ultra quiet operation
- Motion sensor for maximum efficiency
- Smart Replacement Filter Indicator
- No modifications to existing HVAC system required

PURAFLO: Commercial Fan Filter Unit

- Cleanroom-grade HEPA filtration
- Easy to install with no impact on existing HVAC
- Floor mount for immediate use or ceiling mount for permanent solution
- Dual-outlet reverse flow configuration able to increase air change rate and create negative room pressure

CARES: Critical Area Recirculation/Exhaust Systems

- Part of the Pandemic-Ready Patient Room solution that converts a standard patient room to a negative pressure isolation room at the touch of a button
- Combines a reverse flow Fan Filter Unit (with HEPA) and a one-way, radial diffuser to manage airflow for an entire patient room

CUSTOM AIR HANDLING UNITS



UNITECH
www.unitechair.com

- Units ranging from 2,000 CFM to 300,000 CFM (Catalogued from 5,000 CFM to 91,000 CFM)
- Maximum sound attenuation with four inch, double wall construction
- Penthouse units available up to 400,000 CFM
- Factory-installed controls and piping available
- Cooling Options: Hydronic or DX (Packaged Air-Cooled or Water-Cooled available)
- Heating Options: Hydronic, Steam, Electric or Gas
- Humidification Options: Gas, Electric or Steam-to-steam
- Knockdown construction available
- Custom Air Handlers

LABORATORY, CRITICAL ENVIRONMENT & SPECIALIZED EXHAUST PRODUCTS



Price Industries Limited
www.priceindustries.com

- Ultrasuite O.R. System
- Common Plenum Lamina Array
- Hospital Grade Ceiling Systems
- Air Curtain Systems (HORD System)
- Fan Filter Units
- Laminar Flow Diffusers
- Radial Flow Diffusers
- Return and Exhaust Grilles
- Fume Hoods

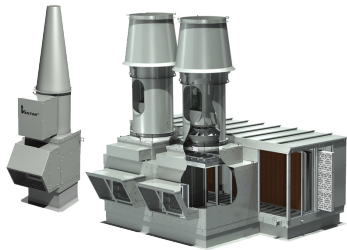

Greenheck
www.greenheck.com

- Vektor Laboratory Exhaust Systems
- Meets ANSI Z9.5, NFPA 45, UL 705 and ASHRAE Chapter 44 Lab Design Guidelines
- Stack Exhaust Fans Designed for 125mph Winds Without Guy Wires
- Minimal Footprint on Roof, Quick and Easy Installation
- Suitable for Constant or Variable Volume Systems Using Bypass Section
- SAVVE Technology – Variable Nozzle Technology to Allow Motor Speed to be Reduced While Maintaining Discharge Velocity



Antec Controls
www.antecontrols.com

- Valves
 - Venturi Valves – High Turndown Ratio and Mechanical Pressure Independence
 - Venturi FX – Measured Airflow and Low Pressure Operation
 - Integrated Venturi Valve Assembly Options
 - Performance Guaranteed Venturi with Integrated Silencer Assemblies
 - AHRI 410 Certified Venturi with Hot Water Coil Assemblies
 - UL1995 Certified Venturi with Electric Coil Assemblies
- Monitors and Controls
 - Room Monitors
 - Touchscreen Room Pressure Monitor – High Resolution Touchscreen Display
 - Multi-Variable Monitor – High Resolution Touchscreen Displaying up to 8 Rooms on Main Screen
 - All Monitors Have Native BACnet MS/TP Connection
 - Pace™ Critical Space Controller
 - Volumetric Offset or Pressure Control
 - Temperature and Humidity Control
 - Fume Hood Controls
 - Fume Hood Controller
 - Sash Position Sensing Fume Hood Control
 - Sidewall Sensing Fume Hood Control
 - Hybrid Fume Hood Control
 - Presence Sensing
 - Fume Hood Interface

LABORATORY, CRITICAL ENVIRONMENT & SPECIALIZED EXHAUST PRODUCTS CONT'D

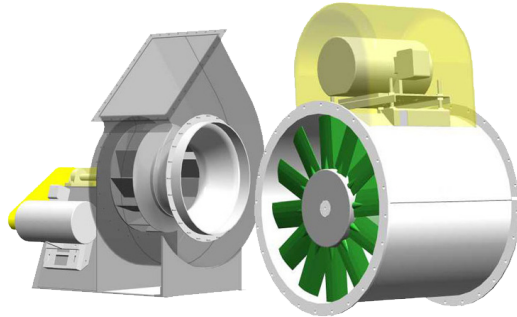

Universal Fan
www.universalfan.com

- Composite FRP / Corrosion Resistant
- Centrifugal and Axial Fans
- Wall Exhaust Fans
- Resistant Ductwork



Flow Sciences
www.flowsciences.com

- Containment Systems for Laboratory, Pilot Plant and Manufacturing Areas
- Specialists in Nanotechnology and Powder Containment
- Dedicated Engineers on Staff to Assist in Custom Equipment



Nederman
www.nederman.com

- Fume Extraction Arms and Fans
- Bench Top Flexible Extraction Arms and Fume Cabinets
- Filter Carts and Filter Box Mobile Fume Extractors
- Vehicle Exhaust Fume Extractors and Hose Reels
- Fume Extraction Rail Systems
- Electrostatic and Oil Mist Filters
- Magna Track Fire Station Exhaust Extractors for Rescue Vehicles



Unisorb Canada
www.unisorb.ca

- Specialists in Air and Gas Purification
- Corrosion and Odor Control
- Environmental Emission Control
- Personnel Protection

FANS



Greenheck
www.greenheck.com

- Commercial Fans
- Industrial Process Fans
- Gravity Ventilators
- Fiberglass Reinforced Plastic (FRP) Fans for Resistance to Extremely Corrosive Gases / Environments

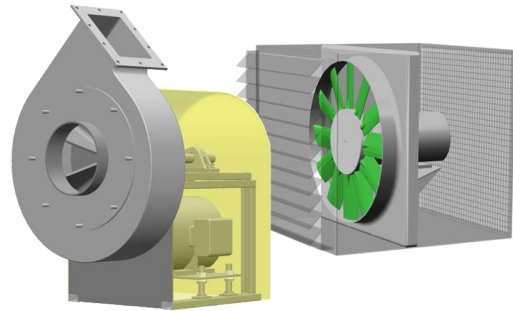

Universal Fan
www.universalfan.com

- Composite FRP / Corrosion Resistant
- Centrifugal and Axial Fans
- Wall Exhaust Fans
- Resistant Ductwork

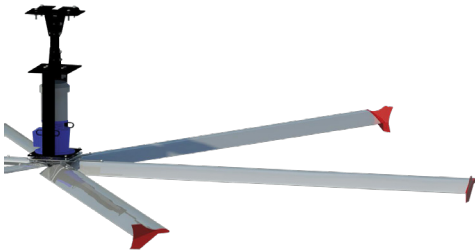

SkyBlade Fan Company
www.skybladefans.com

- Large Fans for Commercial and Industrial Applications
 - Summer Cooling
 - Winter Destratification / Heat Recirculation
- High Volume, Low Speed Fans
- 12' to 20' Diameter



Canarm/Leaderfan
www.canarm.com

- Industrial High Performance Ceiling Fans
- Roof Supply and Exhaust Fans
- Wall Supply and Exhaust Fans
- Inline Duct Fan
- Man Coolers
- Circulating Fans

FANS CONT'D



Delhi
www.delhiindustries.com

- Commercial Fans
 - Duct and Utility Blowers
 - Roof Exhausters
- Tube Axial Fans
- Fresh Air Supply Units



Fantech
www.fantech.net

- Inline Duct Fans
- Bathroom / Kitchen Exhaust Fans
- Round Backdraft Dampers
- Lint Traps
- Heat Recovery Ventilators



Broan/NuTone
www.broan-nutone.com

- Kitchen Range Hoods, Exhaust Fans and Ventilators



GNN Fans

- Economical Ceiling Ventilation Fans

AIR CURTAINS

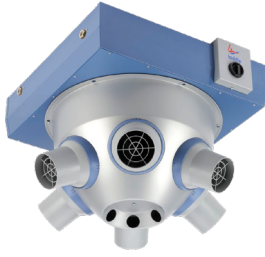

Biddle Climate Solutions
www.biddle.ca

- Commercial, Retail and Industrial Air Curtains
- NOZ Adjustable Nozzle Unit Heater for High Induction

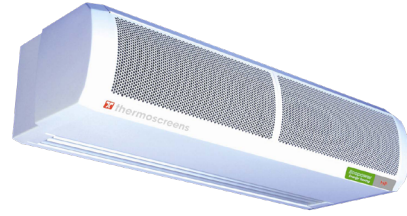

Thermoscreens
www.thermoscreens.com

- Commercial, Retail and Industrial Air Curtains
- NOZ Adjustable Nozzle Unit Heater for High Induction

MAKE-UP AIR UNITS & AIR HANDLERS



SolutionAir
www.solutionairgroup.com

- Air-Cooled DOAS Units
 - Up to 20,000 CFM
 - Heating Options: Gas, Electric, Steam and Hydronic
 - Cooling Options: Hydronic and DX (Packaged or Split)
 - Energy Recovery Options
- Customizable Air Handlers
 - Up to 100,000 CFM
 - Indoor / Outdoor Construction
 - Single / Double Wall Construction
 - Heating Options: Gas, Electric, Steam and Hydronic
 - Cooling Options: Hydronic and DX (Packaged or Split)
 - Energy Recovery
 - Packaged Control
- Make-Up Air Units
 - Direct Fired: 250 – 15,000 MBH
 - Indirect Fired Drum and Tube: 200 – 6,000 MBH
 - Indirect Fired Convolved Tube: 75 – 1,200 MBH
 - 90% Efficient Indirect Fired: 250 – 1,600 MBH
- Rooftop Units (8 – 250 Tons)
 - Highly Configurable
 - Heating Options: Indirect Gas, Electric, Steam and Hydronic
 - Cooling Options: Hydronic and DX (Packaged Up to 160 Tons and Split Up to 250 Tons)
 - Energy Recovery Options



Greenheck
www.greenheck.com

- Direct and Indirect Gas Fired Make Up Air Units
- Indoor Air Handling Units
- Electric Heating, Hot Water, Chilled Water and DX Options

KITCHEN VENTILATION SYSTEMS



Greenheck
www.greenheck.com

- Wall, Island Proximity and Heat, Condensate Hoods
- Internal and External Supply Plenums Optional
- Standard Baffle Filter, High Velocity Cartridge, High Efficiency Grease-X-Tractor and Dual Stage Grease Grabber, Filtration
- Flexconnect Utility Distribution System
- Factory Built Wall Utility Systems Offering Single Point Connections for Gas, Water and Electricity
- Easy to Clean Stainless Steel Exterior
- Adds Flexibility, Easy Relocation of Equipment, Reduces Installation Time, Allows Integration of Controls and Concealment of All Pipes and Wiring

ELECTRIC HEATING

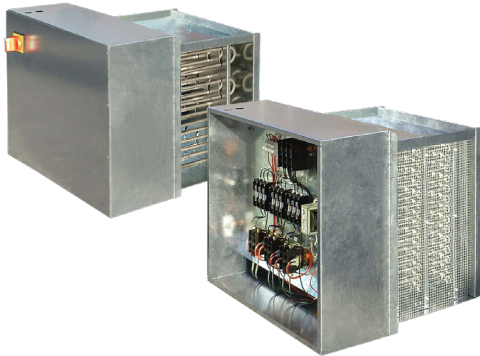

Price Industries Limited
www.priceindustries.com

- Electric Duct Heaters
 - Open or Tubular Coils



Ouellet Electric Heating
www.oullet.com

- Electrical Heating Products
 - Residential
 - Commercial
 - Industrial
 - Architectural
 - Baseboard Heaters
- Unit Heaters
- Portable Heaters
- Draft Barriers
- Wall Heaters
- Diffuser Heaters
- Radiant Heaters
- Cabinet Convector

FAN COILS & HYDRONIC HEATING AND COOLING



Price Industries Limited
www.priceindustries.com

- Chilled Beams
 - Linear, Modular, Horizontal, Vertical and Floor-Mounted Active
 - Linear Passive
- Passive with Integrated Returns
- Controls and Hose Kits
- Retrofit Perimeter Induction Units

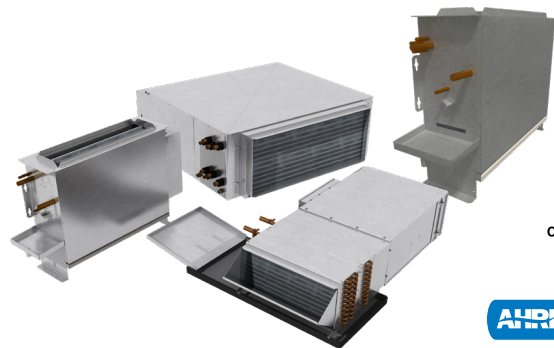

Price Industries Limited
www.priceindustries.com

- High Performance Fan Coils
 - Optional Integrated Silencer
 - Standard ECM Motor
- Horizontal Blower Coils
- Vertical Fan Coils
 - Concealed and Exposed

FAN COILS & HYDRONIC HEATING AND COOLING CONT'D



Greenheck
www.greenheck.com

- High Performance Fan Coils
- Coils
 - Chilled Water
 - Hot Water
 - DX Evaporator
- Heat Reclaim
- Condenser
- Standard Steam
- Non-Freeze Steam Distributing
- Booster / Duct Mounted



Nu-Air Ventilation
www.nu-airventilation.com

- Enerboss Integrated Air Handlers and Fan Coils with Optional Integral HRV



Vulcan Radiators
www.vulcanrad.com

- Commercial Hydronic Heating Products including:
 - Commercial Wall-Fin Radiation
 - Light Commercial Wall-Fin Radiation
 - Cabinet Unit Heaters
- Convectors
- Horizontal and Vertical Unit Heaters
- Panel Radiators
- Custom Enclosure
- Security Enclosure

HEAT & ENERGY RECOVERY

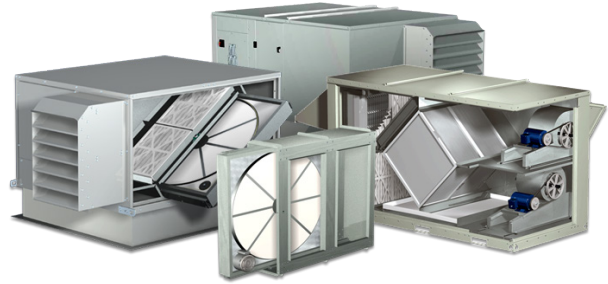

SolutionAir
www.solutionairgroup.com

- RegenCore Alternating Mass-Exchanger Energy Recovery Units
 - No Pre-Heat Requirements Down to Outdoor Temperatures of -40°C
 - Up to 92% Effectiveness



Greenheck
www.greenheck.com

- Minivent Interior ERV
- PVE Plate Heat Exchanger
- ERV and ERVE Energy Recovery Units
- RVE Packaged Air Handler with Integral Energy Recovery

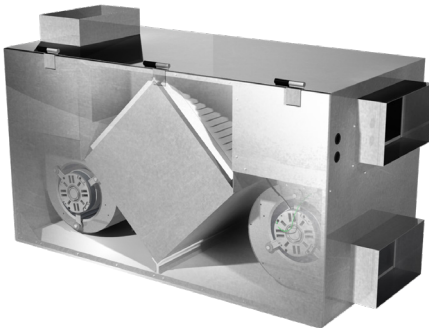

RADIANT HEATING & COOLING



Nu-Air Ventilation
www.nu-airventilation.com

- Residential HRVs and ERVs
- Commercial HRVs and ERVs
- Enerboss Integrated Air Handlers & Fan Coils
- Air Exchangers, Passive HRVs and Wet Basement Solutions
- Controls and Accessories



InfraSave by Schwank
www.infrasave.com

- Gas Fired Infrared Radiant Heaters
- Tube and Luminous Style Radiant Heaters
- Patio Heaters

CONTROLS

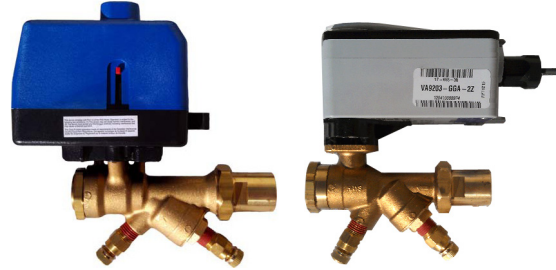

Franklin Control Systems
www.franklin-controls.com

- HVAC Specialty Products
 - Building Automation Starters
 - Standard Automation Starters
 - Cooling Tower Controls
 - Kitchen Hoods Controls
 - Pump and HVAC Controls
- Industrial Products
 - Contactors and Overload Relays
 - Manual Motor Starters
 - Circuit Breakers
 - Starters
 - Soft Starters
 - Soft Starters with Integrated Bypass
 - Programmable Logic Controllers
 - Terminal Blocks
 - Pilot-Devices
 - Enclosures



Hays Fluid Control
www.haysfluidcontrols.com

- Manual and Automatic Flow Controls
- Hose Kits and Piping Packages, Fully Assembled and Tested
- Solenoid Valves
- Custom-Designed Fluid Control Products for a Wide Range of Unique Applications



Belimo
www.belimo.com

- Electric Damper Actuators and Control Valves

CONTROLS CONT'D



price | CONTROLS

Price Industries Limited
www.priceindustries.com

- Application Specific Controls For:
 - Networked or Stand-Alone Applications
 - VAV/WT Controllers (BTL Certified)
 - Mini-Front-End Solutions
- Pneumatic Stand-Alone Controls
- Control Applications:
 - Rooftop Controls
 - Bypass Controls
 - Single Duct Controls
 - Fan Powered Controls
 - Prodigy Smart Diffusers
 - Web Server Graphical Interface
 - Hydronic Controls
 - Underfloor Controls

Honeywell
ANALYTICS

Honeywell Analytics
www.honeywellanalytics.com

- Commercial Gas Detection Systems
- Monitors, Controllers and Hand-Held Products



Above: Chilled Beams

ACTIVE & PASSIVE BEAMS

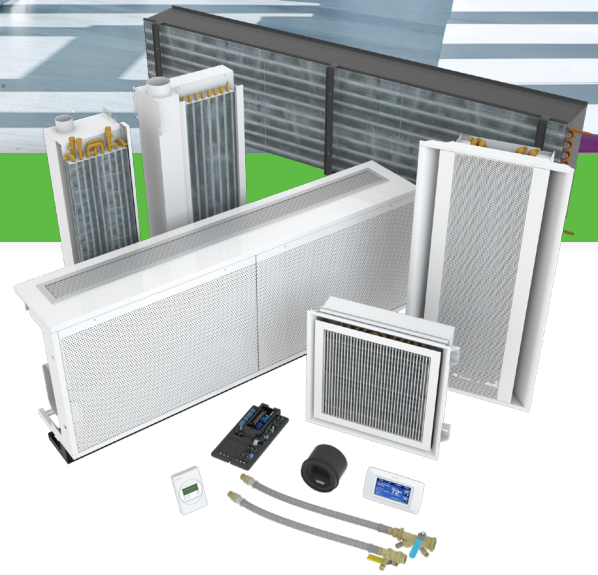

BUILDING APPLICATIONS

- + Thermal comfort is a major design consideration
- + Spaces with high sensible heat releases
- + Spaces requiring high indoor air quality (100% fresh air)
- + Spaces requiring energy conservation

AIR-WATER SYSTEM BENEFITS

- + Reduced system power consumption
- + Reduced maintenance costs
- + Environmental quality
 - Improved indoor air quality
 - Improved thermal comfort
- + Reduced mechanical footprint

ACTIVE & PASSIVE BEAM TYPES

- + Active linear, vertical, horizontal, modular, perimeter induction units, exposed, and floor mounted cabinets
- + Passive linear beams
- + Passive beams with integrated return

SMART STARTERS AND VFDs

Advanced Across the Line Solutions for HVAC Applications

HVAC Specialty Products

- Building Automation Starters
- Standard Automation Starters
- Cooling Tower Controls
- Kitchen Hoods Controls
- Pump & HVAC Controls



NEMA Rated  



Industrial Products

- Contactors and Overload Relays
- Manual Motor Starters
- Circuit Breakers
- Starters
- Soft Starters
- Soft Starters with Integrated Bypass
- Programmable Logic Controllers
- Terminal Blocks
- Pilot-Devices
- Enclosures



Heavy Duty / Industrial Dampers

Designed for use in industrial and severe duty applications

Heavy duty flanged style frame dampers with various blade styles and pressure classes. Designed to control airflow and provide shut off in HVAC or industrial process control systems.

Heavy-Duty/Industrial Dampers: HB, HBTR, HPR, HCD, HCDR, HSD, and HTD Series

Damper Applications: Control and Isolation, Backdraft, Pressure Relief, Tunnel Transit, Smoke, Blast/Tornado, Custom Products

Vari-Green® Motor

Start saving now - with the low-cost, easy to control, electronically commutated motor that offers high reliability and low maintenance.

The Greenheck Vari-Green Motor blends technology, controlability, and every-efficiency into a low maintenance package that is changing the way industry designs, specifies and operates air movement equipment.

www.greenheck.com

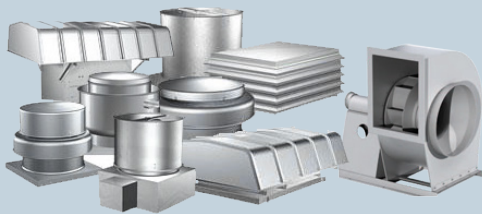

Commercial & Industrial Fans

- Commercial Fans
- Industrial Process Fans
- Gravity Ventilators
- Fiberglass Reinforced Plastic (FRP) Fans for resistance to extremely corrosive gases/ environments

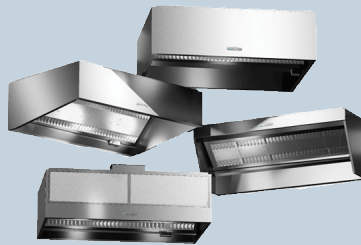

Kitchen Ventilation Systems

- Wall, island proximity and heat, condensate hoods
- Internal and external supply plenums optional
- Standard baffle filter, high velocity cartridge, high efficiency Grease-X-Tractor and dual stage Grease Grabber, filtration.

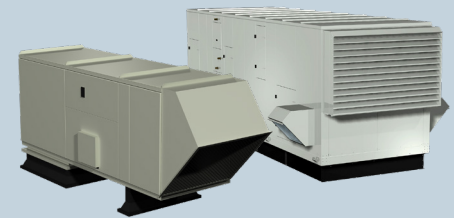

Make-Up Air Units & Air Handlers

- Direct and Indirect Gas Fired Make Up Air Units
- Indoor Air Handling Units
- Electric heating, hot water, chilled water and DX options



Building Value in Air
World Wide

www.greenheck.com



First in Quality, First in Service

E.H. PRICE OTTAWA

3236 Hawthorne Road

Ottawa, ON, Canada K1G 3W9

Ph: 613.725.2029

Email: ottawa@ehpricesales.com

Website: www.ehpriceottawa.com



Local Delivery Available • Contact your E.H. Price Sales Representative for more information

LONDON

2351 Huron Street

Unit #6

London, Ontario

N5V 3K4

Ph: 519.451.5100

Fax: 519.451.8726

london@ehpricesales.com

www.ehpricesouthwesternontario.com

CAMBRIDGE

75 Saltsman Drive

Unit #8

Cambridge, Ontario

N3H 4R7

Ph: 519.653.9470

Fax: 519.653.7853

cambridge@ehpricesales.com

www.ehpricesouthwesternontario.com

HAMILTON

70 Unsworth Drive

Unit #11

Hamilton, Ontario

L8W 3K4

Ph: 905.383.3599

Fax: 905.383.1274

hamilton@ehpricesales.com

www.ehpricehamilton.com

TORONTO

571 Chrislea Road

Unit #3

Woodbridge, Ontario

L4L 8A2

Ph: 905.669.8988

Fax: 905.669.8023

toronto@ehpricesales.com

www.ehpricetoronto.com

OSHAWA

500 Wentworth Street East

Unit #12

Oshawa, Ontario

L1H 3V9

Ph: 905.669.8988

Fax: 905.669.8023

oshawa@ehpricesales.com

www.ehpriceoshawa.com

SUB REP - SUDBURY & N.E. ONTARIO

Jack Dougan Associates

74 Mumford Drive

Lively, Ontario

P3Y 1H9

Ph: 705.692.5838

Fax: 705.692.5685

www.jdaltd.ca

SUB REP - WINDSOR

LK Metal Products Co. Limited

1595 Lincoln Road

Windsor, Ontario

N8Y 2J3

Ph: 519.256.1861

Fax: 519.256.2828

mail@lkmatal.com

www.lkmatal.com